

Plummer block

SD3000 Series-SD3038

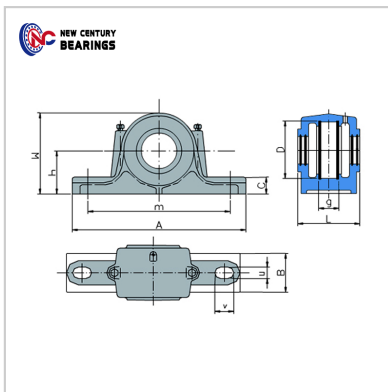

Bearing Number : SD3038

Boundary dimensions(mm) :

D H8 :	290
a :	560
b :	220
c :	50
g H12 :	85
h h12 :	170
L :	250
W :	345
m :	470
n :	120
u :	36
v :	52
s :	M30

Mass(Kg) : 82

: