

Spherical plain bearings

GE...ES-2RS Series-GE100ES-2RS

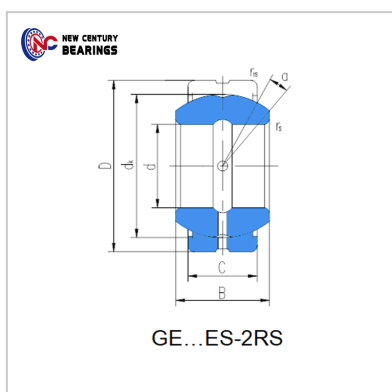

Bearing Number : GE100ES-2RS

Boundary dimensions(mm) :

d :	100
D :	150
B :	70
C :	55
dk :	130
rs min :	1
r1s min :	1
° :	7
MassKg :	4.45

: