

Spherical plain bearings

GE...ES-2RS Series-GE20ES-2RS

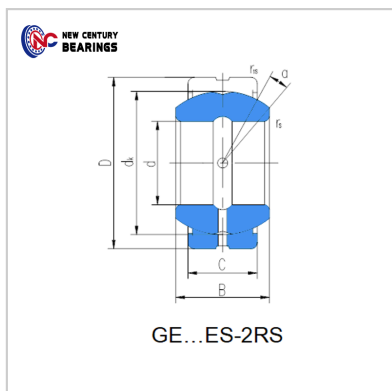

Bearing Number : GE20ES-2RS

Boundary dimensions(mm) :

d :	20
D :	35
B :	16
C :	12
dk :	29
rs min :	0.3
r1s min :	0.3
° :	9
MassKg :	0.066

: