

Spherical plain bearings

GE...ES-2RS Series-GE110ES-2RS

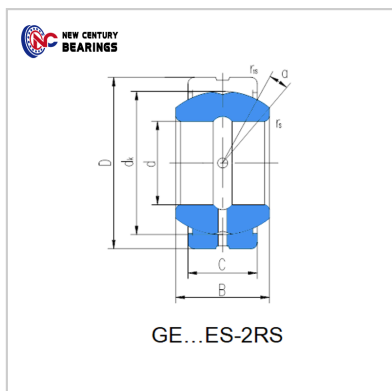

Bearing Number : GE110ES-2RS

Boundary dimensions(mm) :

d :	110
D :	160
B :	70
C :	55
dk :	140
rs min :	1
r1s min :	1
° :	6
MassKg :	4.82

: