

Spherical plain bearings

GE...ES-2RS Series-GE120ES-2RS

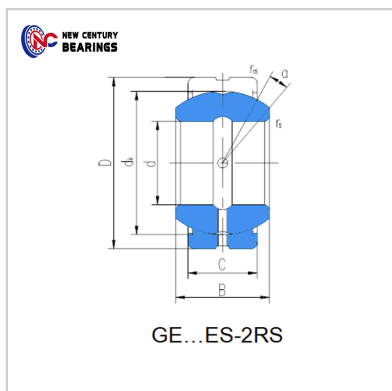

Bearing Number : GE120ES-2RS

Boundary dimensions(mm) :

d :	120
D :	180
B :	85
C :	70
dk :	160
rs min :	1
r1s min :	1
° :	6
MassKg :	8.05

: