

Spherical plain bearings

GE...ES-2RS Series-GE140ES-2RS

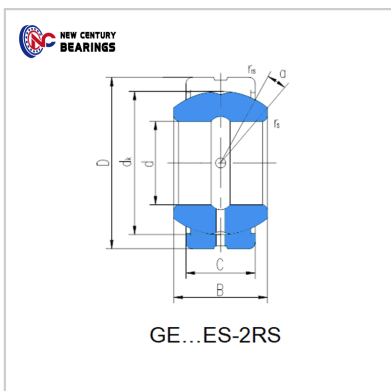

Bearing Number : GE140ES-2RS

Boundary dimensions(mm) :

d :	140
D :	210
B :	90
C :	70
dk :	180
rs min :	1
r1s min :	1
° :	7
MassKg :	11.02

: