

Spherical plain bearings

SIBP...S Series-SIBP6S

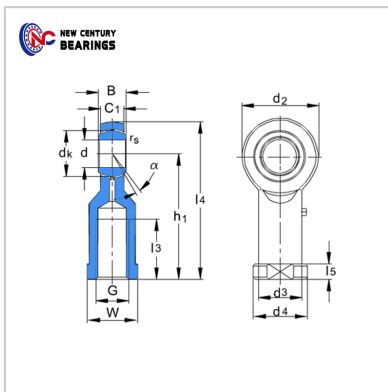

Bearing Number : SIBP6S

Boundary dimensions(mm) :

d :	6
B :	9
dk :	12.7
C1 max :	6.75
d2 max :	18
G 6H :	M6
h1 :	30
l3 min :	14
l4 max :	39
l5 max :	5
W :	11
d3 max :	10
d4 max :	13
rs min :	0.3
° :	13
MassKg :	0.026